

photo overview

ATC 125	ATUP 100	AWD 160	GGP 160	WWU 520
ATC 125 B	ATU 200	AWD 280	MAS 400	WWUP 160
ATC 160	ATU 200 B	AWUP 100 4	MAS 2100	ZAS 100
ATC 250	ATU 200 2	AWU 160 A	MSS 217	ZASP 125
ATC 250 B	ATU 280	AWU 160 B	MSS 400	ZASP 125 B
ATC 300	ATU 400	AWU 160 C	MSS 520	ZAS 160
ATC 350	ATU 520	AWUP 160 D	PW 630	ZAS 160 2
ATD 320	ATU 630	AWU 160 2	SKD 200	ZAS 160 3
ATD 320 B	ATU 800 PAL	AWU 200	SKD 355	ZAS 160 4
ATD 400	ATU 800 B	AWU 200 B	SKHN 520	ZAS 200
ATD 520	ATU 1000	AWUP 200	SKU 200	ZAS 200 B
ATD 520 B	ATU 1000 B	AWU 355	SKU 520	ZAS 200 2
ATD 520 C	ATU 1000 C	AWU 800	STD 310	ZAS 200 4
ATD 630	ATU 1000 D	AWU 800 B	TGW 520	ZAS 280
ATD 800	ATU 1000 E	AWU 800 C	TGW 630	ZAS 280 SPIN
ATD 1000	ATU 1000 H	AWU 800 E	TGZ 520	ZAS 280 2
ATHN 800 SAT355	ATU 1250	AWU 800 F	TGZD 520	ZAS 280 2 B
ATHN 520	ATU 1250 B	AWU 1000 B	WTU 400	ZAS 280 L
ATHN 630	ATU 1600	AWU 1250 B	WW 520	ZAS 280 A
ATHN 800	ATU 1600 B	GG 160	WW 520 V	ZAS 400 B
ATHN 800 PAL	ATU 1600 C	GG 200	WW 630	ZAS 400 C
ATHN 1250	ATU 2000	GG 355	WWD 400	ZAS 400 630

photo overview

ZAS 400 630 L	ZASD 320
ZAS 520	ZASD 320 B
ZAS 630	ZASD 320 C
ZAS 1000	ZASD 320 D
ZAS 1000 A	ZASD 400
ZAS 1000 C	ZASD 400 B
ZASD 100	ZASD 400 C
ZASD 100 A	ZASD 400 D
ZASD 125	ZASR 630
ZASD 125 B	ZASR 1000
ZASD 160	ZATC 125
ZASD 160 B	ZATC 160
ZASD 160 V	ZATC 250
ZASD 160 C	ZATC 300
ZASD 200	ZATC 300 B
ZASD 200 C	ZXD 160
ZASD 200 2	
ZASD 200 2 B	
ZASD 280	
ZASD 280 B	
ZASD 280 C	
ZASD 280 2	

ATC 125



ATC 125 B



ATC 160



ATC 250



ATC 250 B

peiseler



ATC 300

peiseler

ATC 350





ATD 320

ATD 400





ATD 320 B



ATD 520 B



ATD 520 C



ATD 630



ATD 800



ATD 1000



ATHN 800 SAT 355

ATHN 520

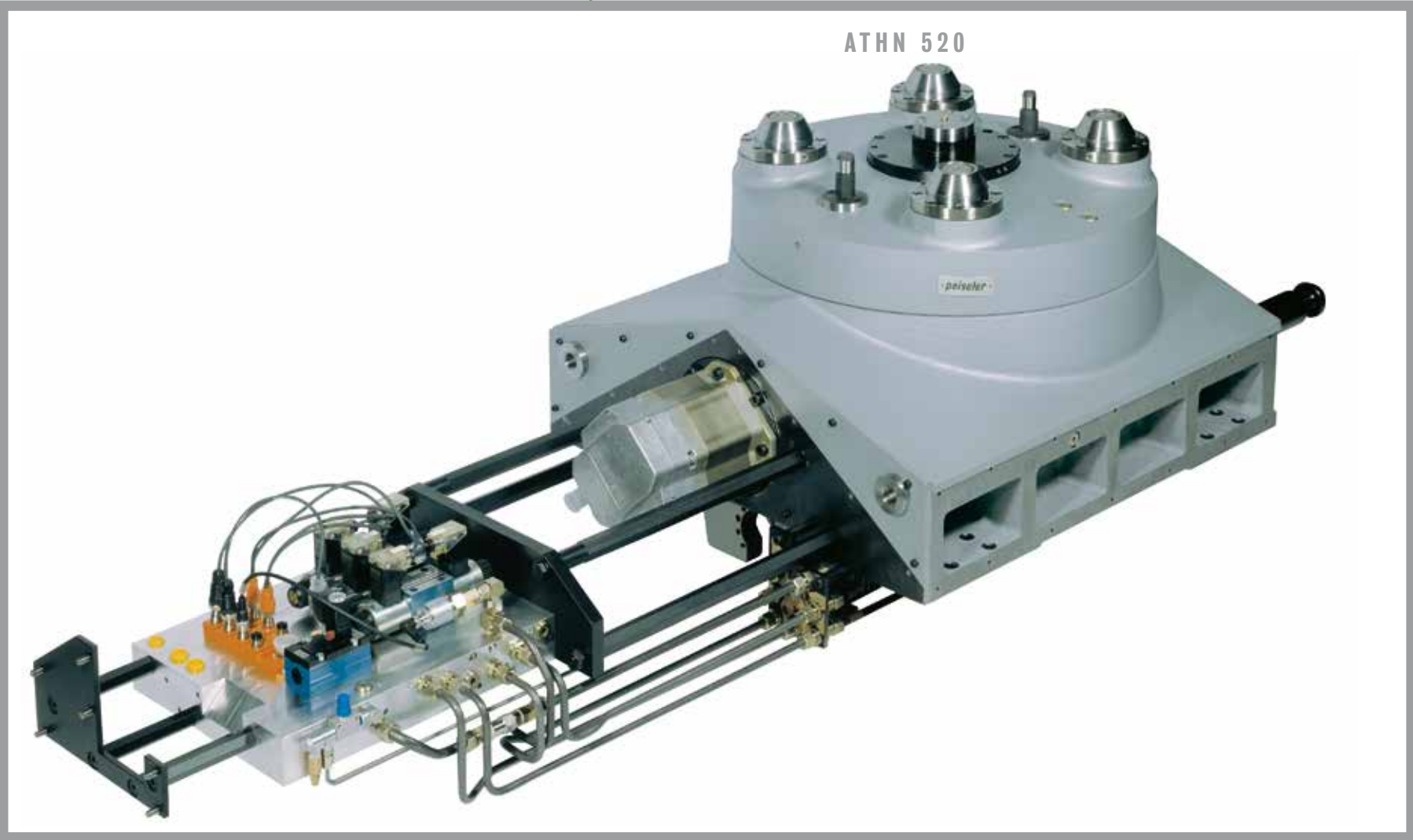

ATHN 630



ATHN 800



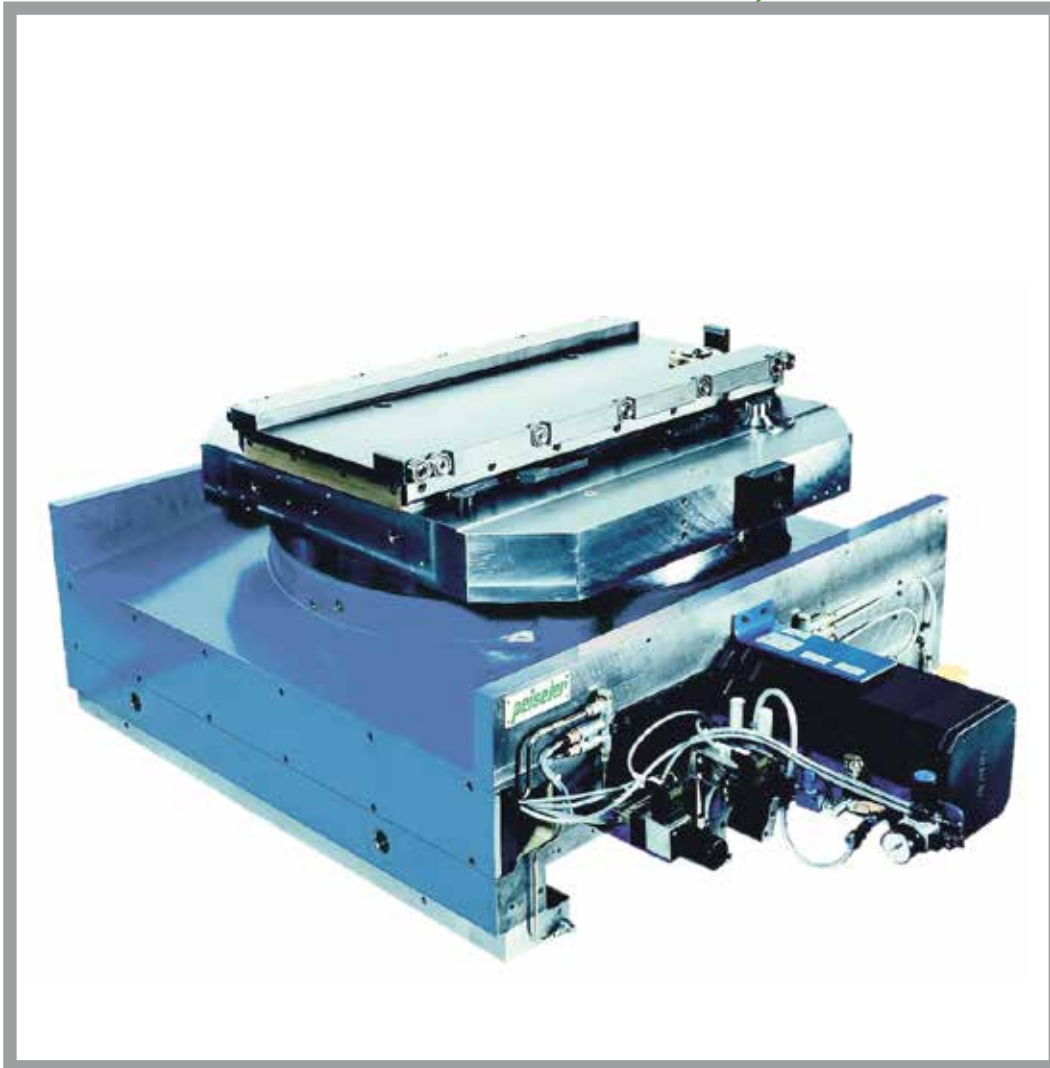

ATHN 800 PAL

ATHN 1250





ATUP 100

ATU 200





ATU 200 B

ATU 200 2



ATU 280



ATU 400





ATU 520



ATU 630

ATU 800 PAL



ATU 800 B





ATU 1000



ATU 1000 B

ATU 1000 C



ATU 1000 D



ATU 1000 E



ATU 1000 H



ATU 1250



ATU 1250 B



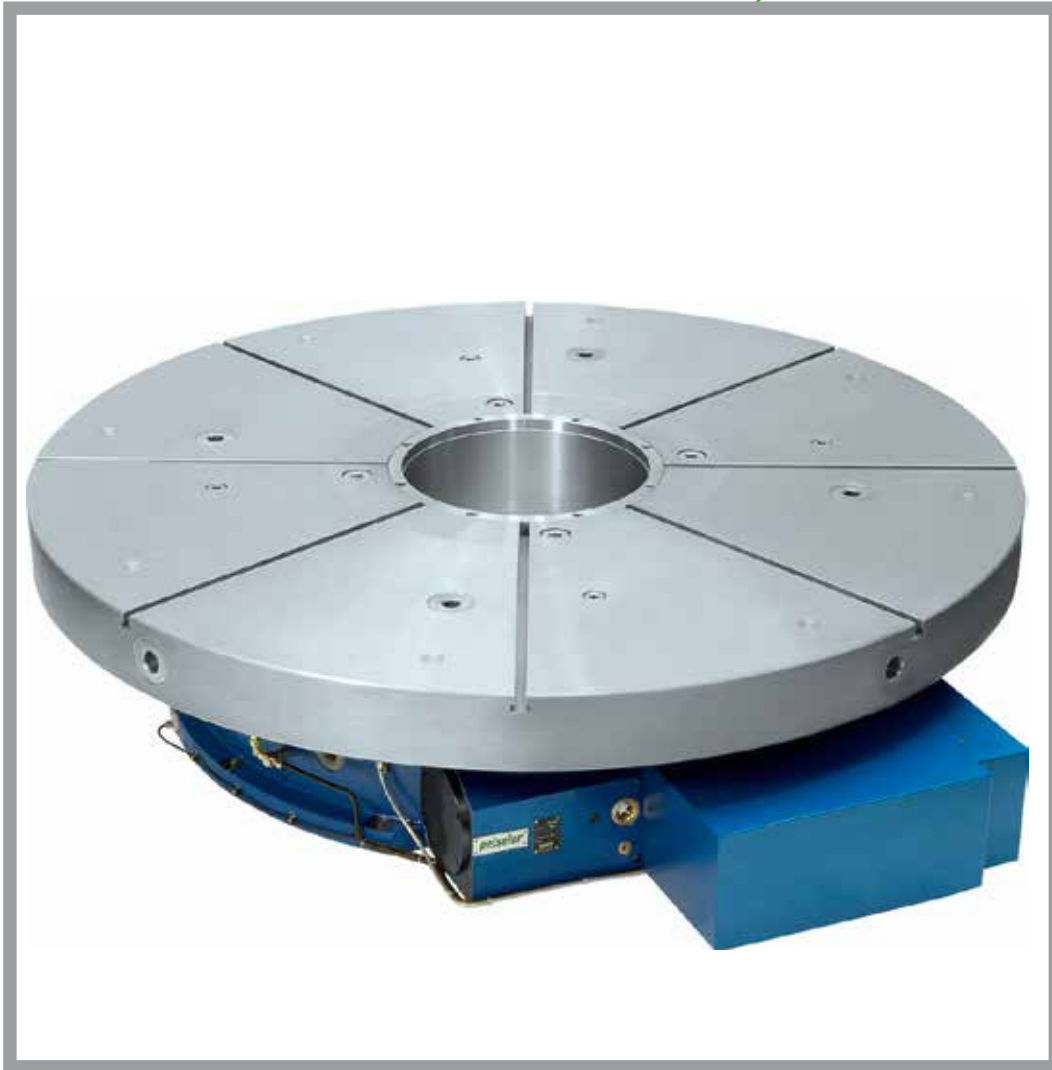

ATU 1600

ATU 1600 B



ATU 1600 C



ATU 2000



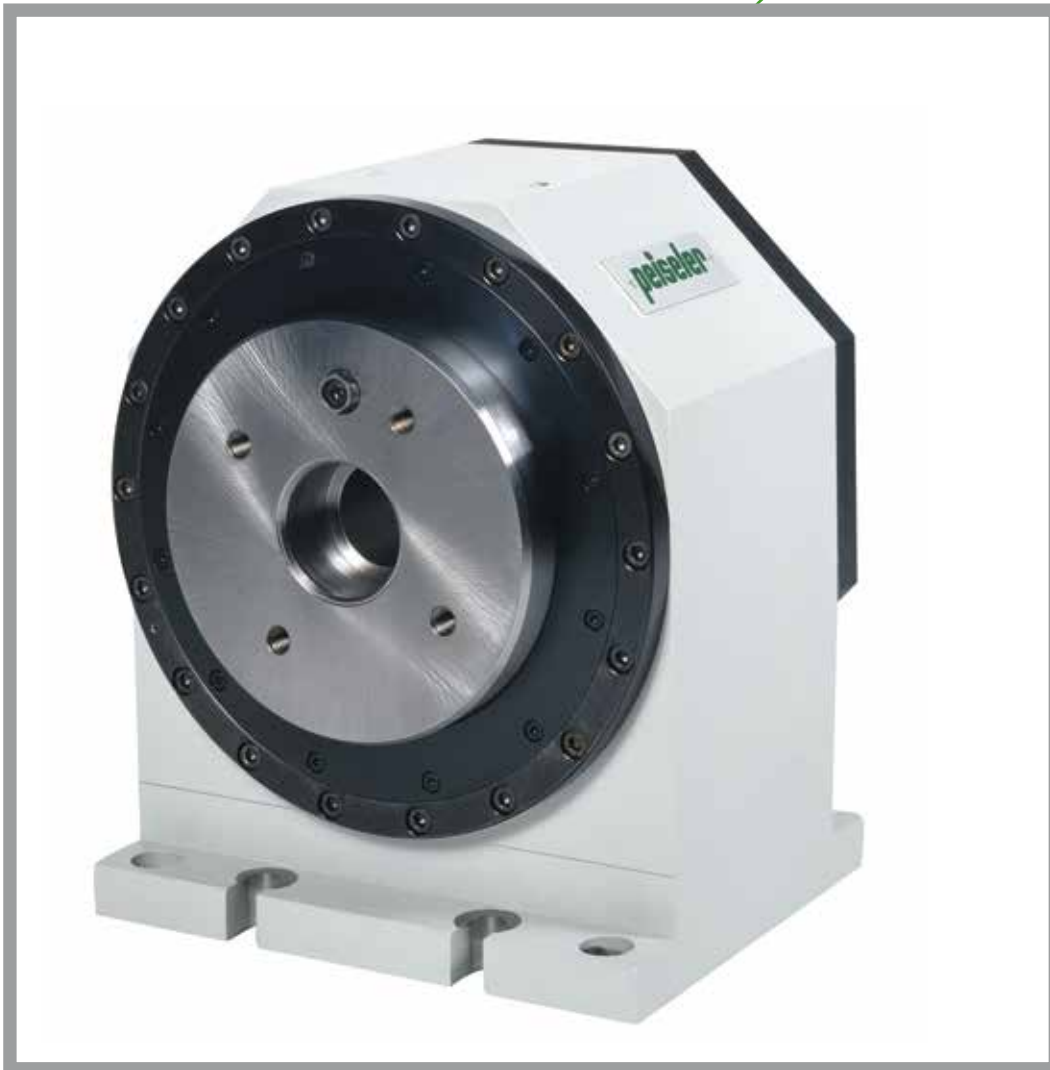

AWD 160



AWD 280

AWUP 100 4





AWU 160 A



AWU 160 B

AWU 160 C



AWUP 160 D





AWU 160 2

AWU 200

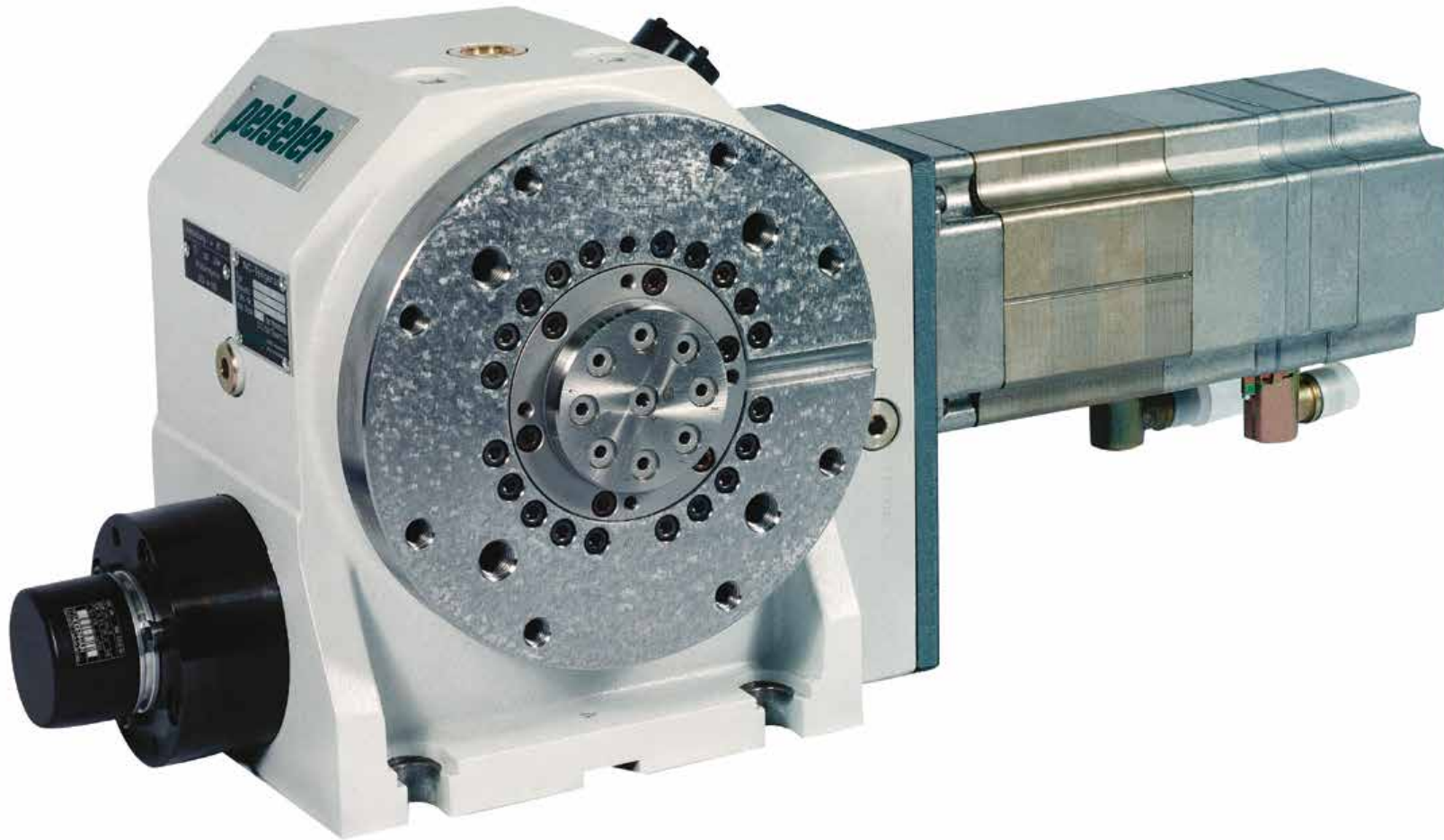

AWU 200 B



AWUP 200





AWU 355

AWU 800





AWU 800 B

AWU 800 C



AWU 800 E



AWU 800 F

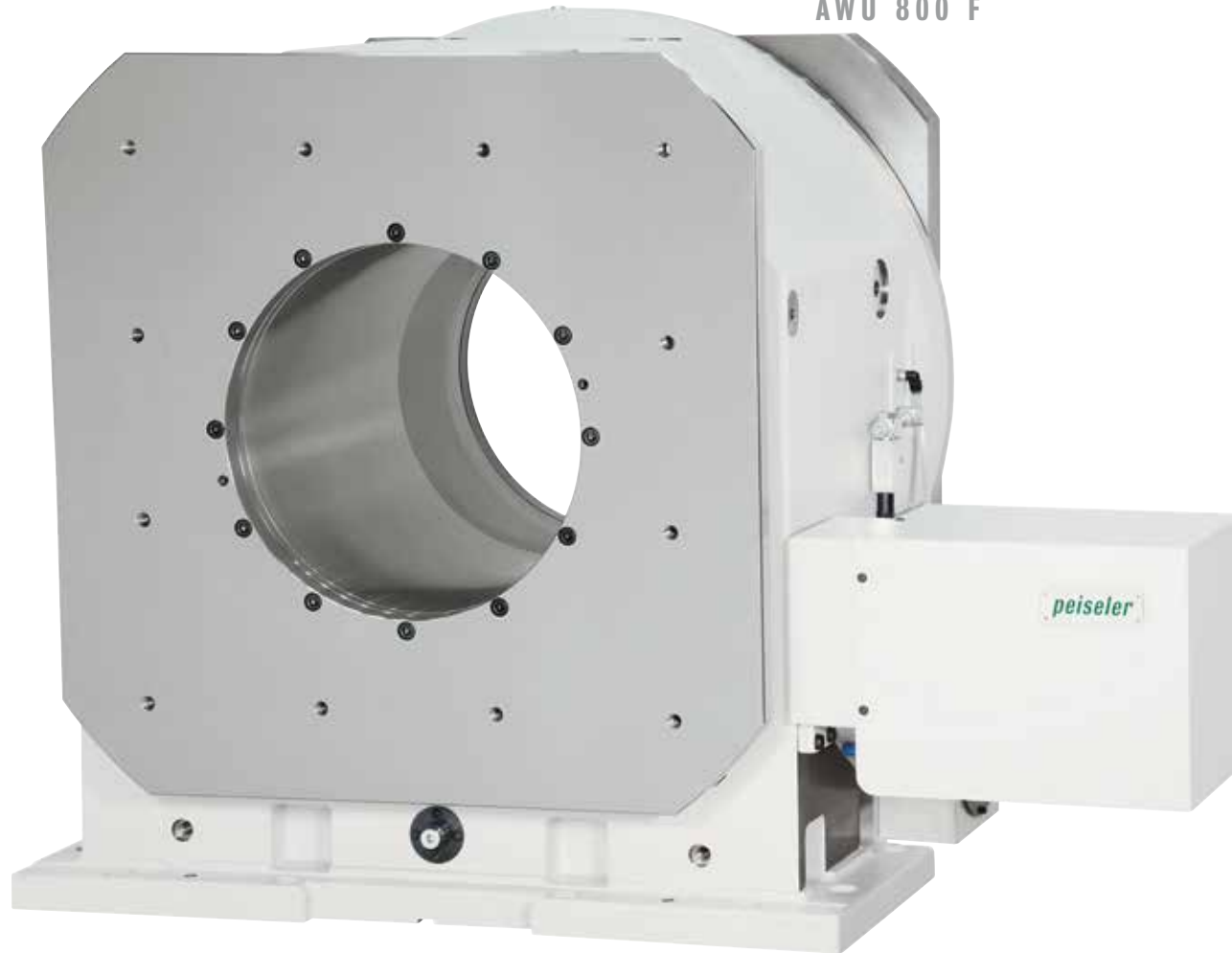

AWU 1000 B

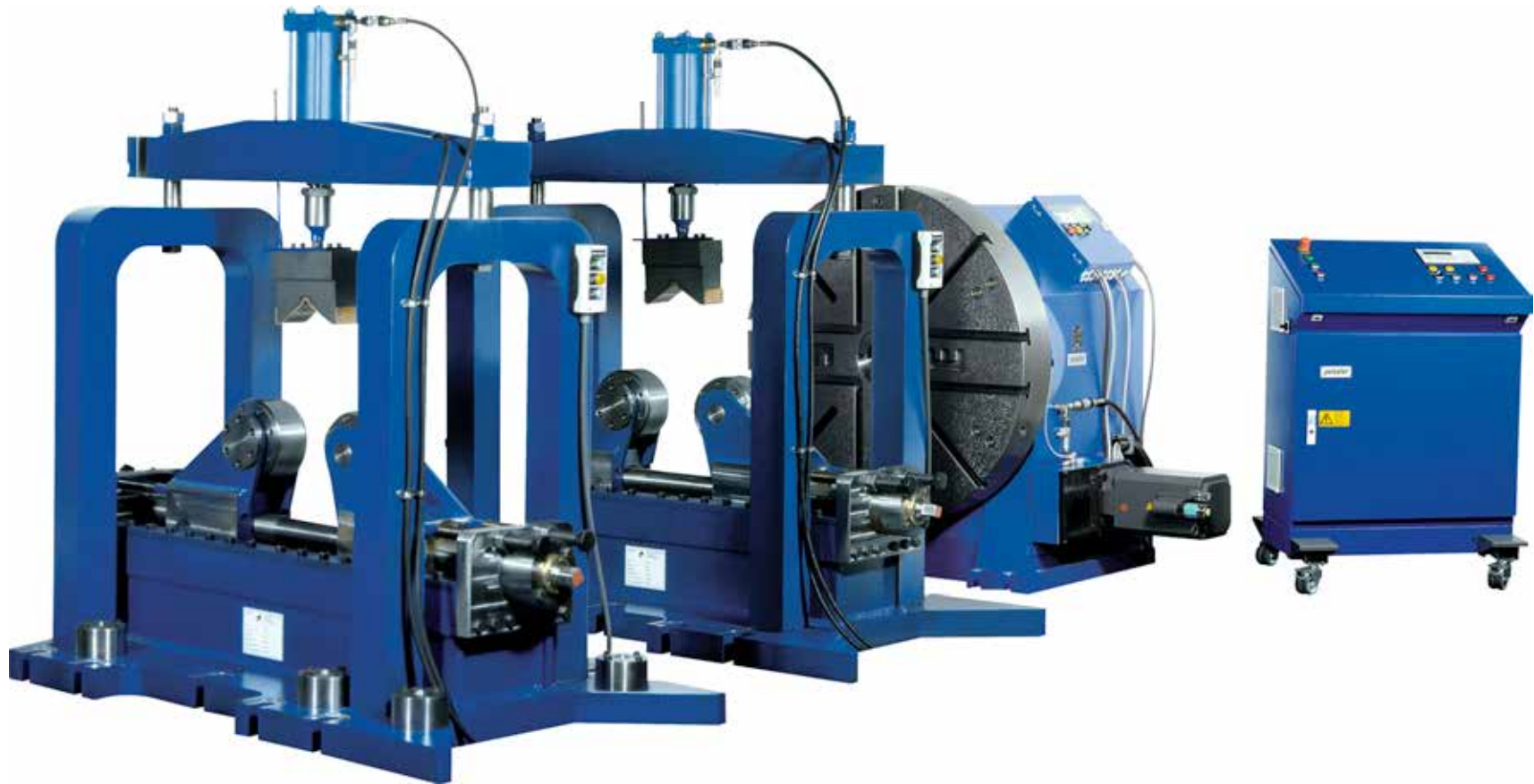



AWU 1250 B



GG 160



GG 200



GG 355



GGP 160



MAS 400

MAS 2100



MSS 217





MSS 400



MSS 520

PW 630



SKD 200





SKD 355



SKHN 520



SKU 200



SKU 520



STD 320

TGW 520

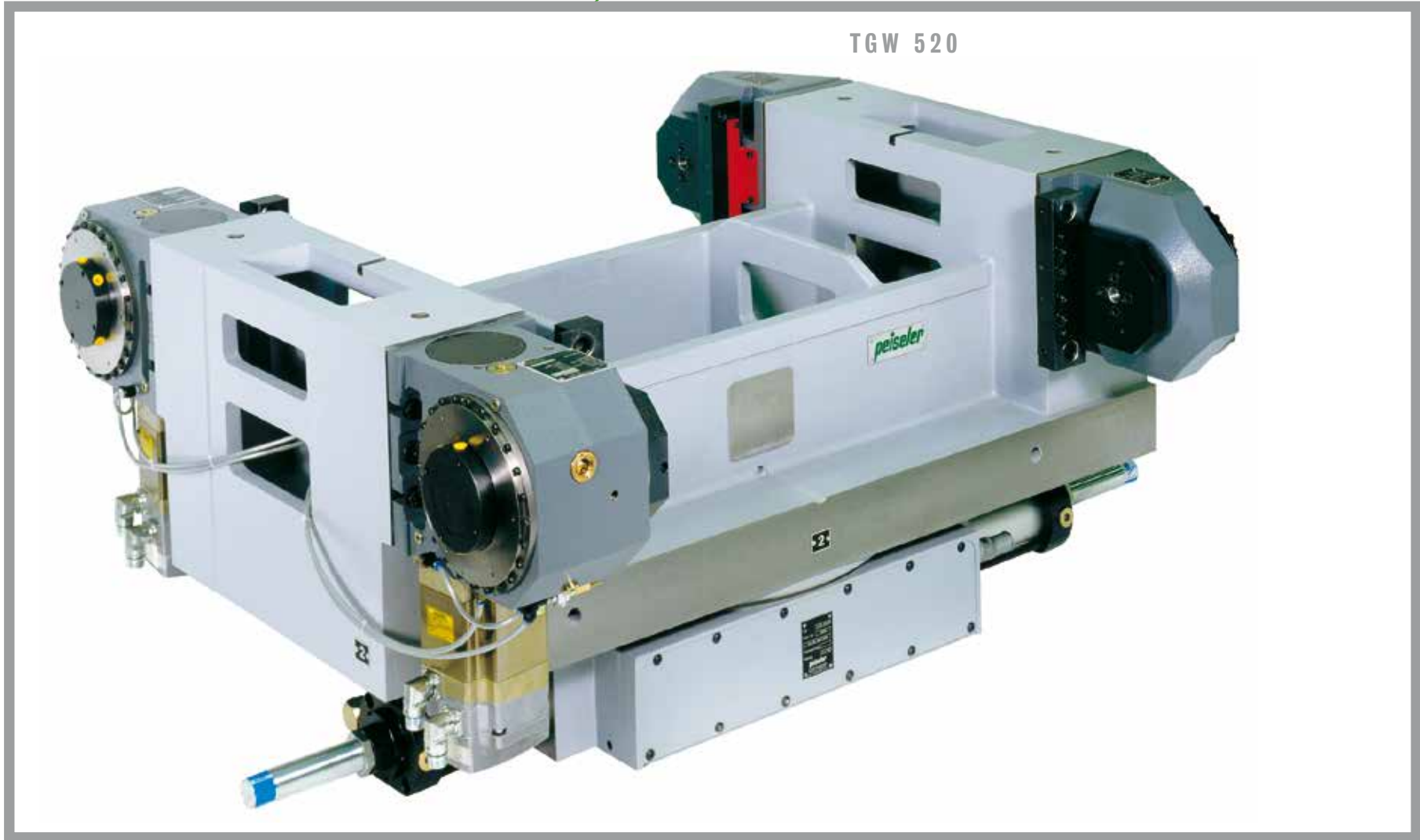

TGW 630

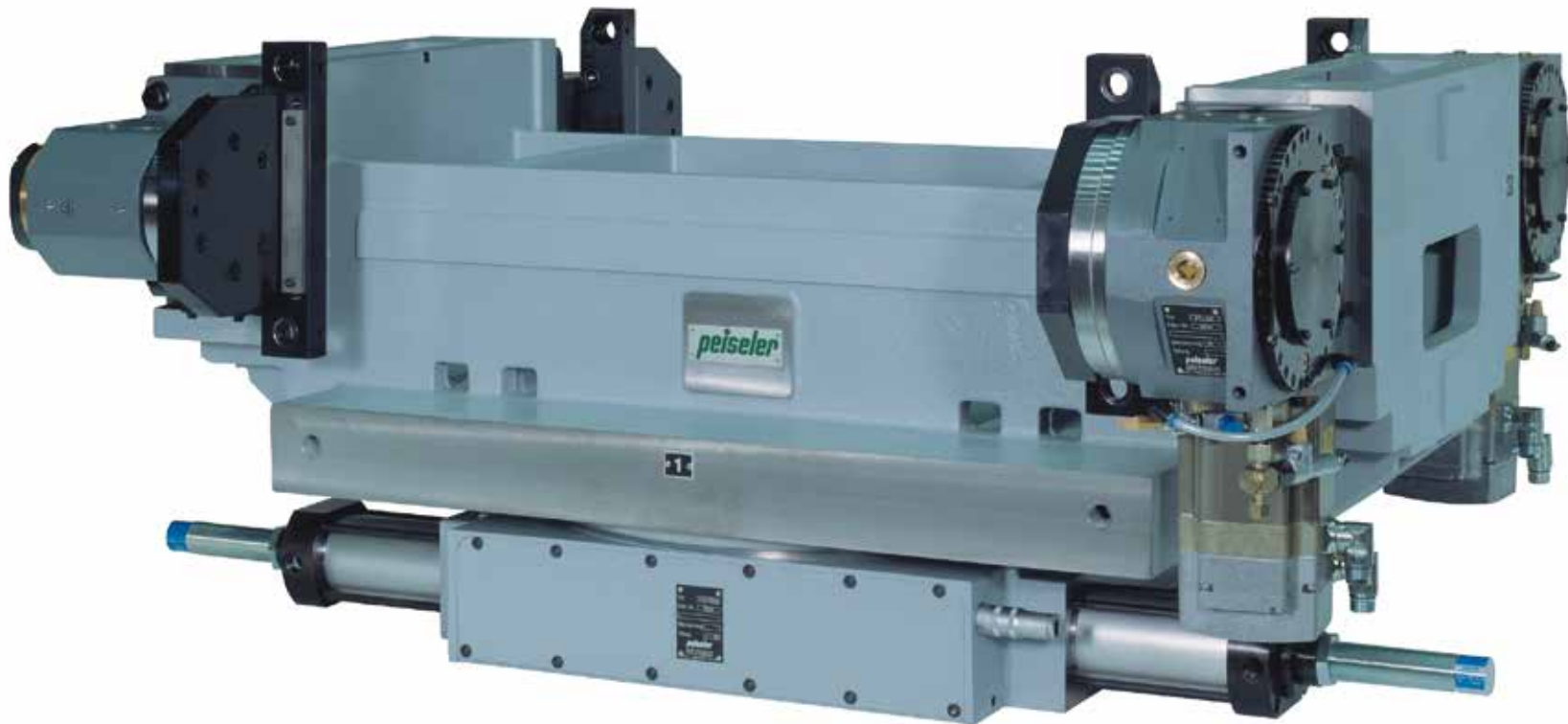

TGZ 520



TGZD 520



WTC 125



WTU 400





WW 520



WW 520 V



WW 630

WWD 400



WWU 520



WWUP 160





ZAS 100

ZASP 125



ZASP 125 B

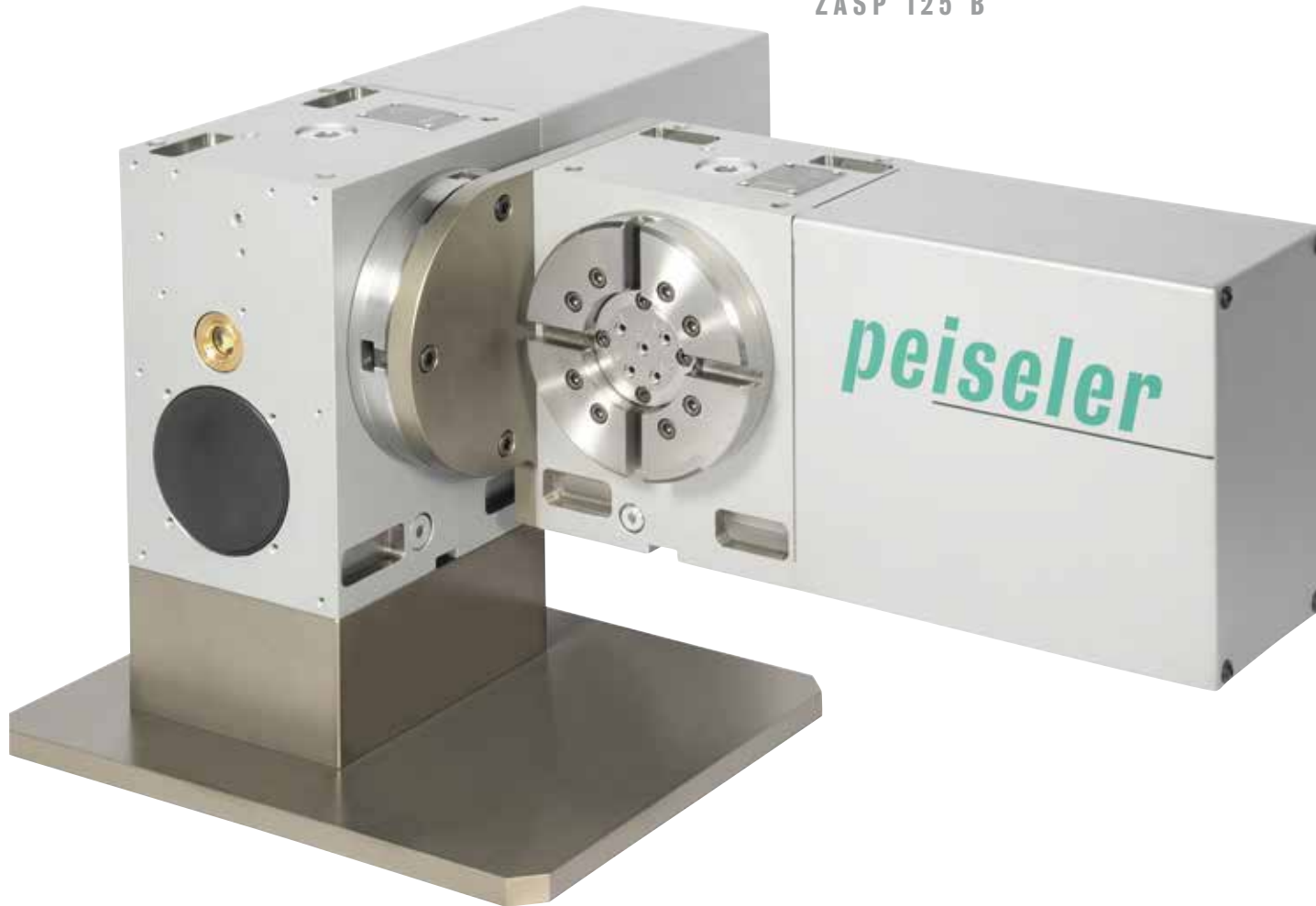



ZAS 160

ZAS 160 2



ZAS 160 3



ZAS 160 4



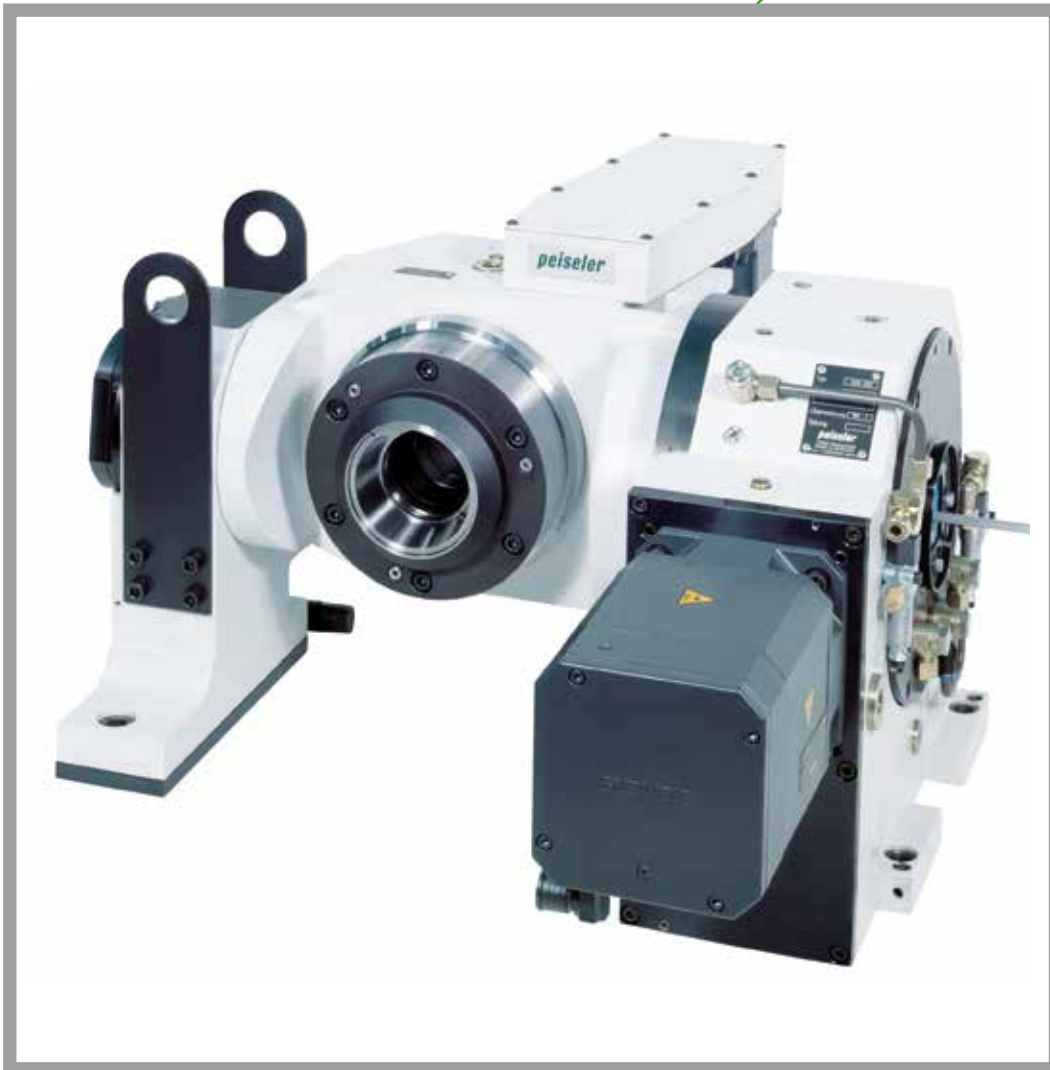

ZAS 200

ZAS 200 B



ZAS 200 2



ZAS 200 4



ZAS 280





ZAS 280 SPIN

ZAS 280 2



ZAS 280 2 B



ZAS 280 L





ZAS 280 A

ZAS 400 B



ZAS 400 C



ZAS 400 630



ZAS 400 / 630 L



ZAS 520



ZAS 630



ZAS 1000



ZAS 1000 A

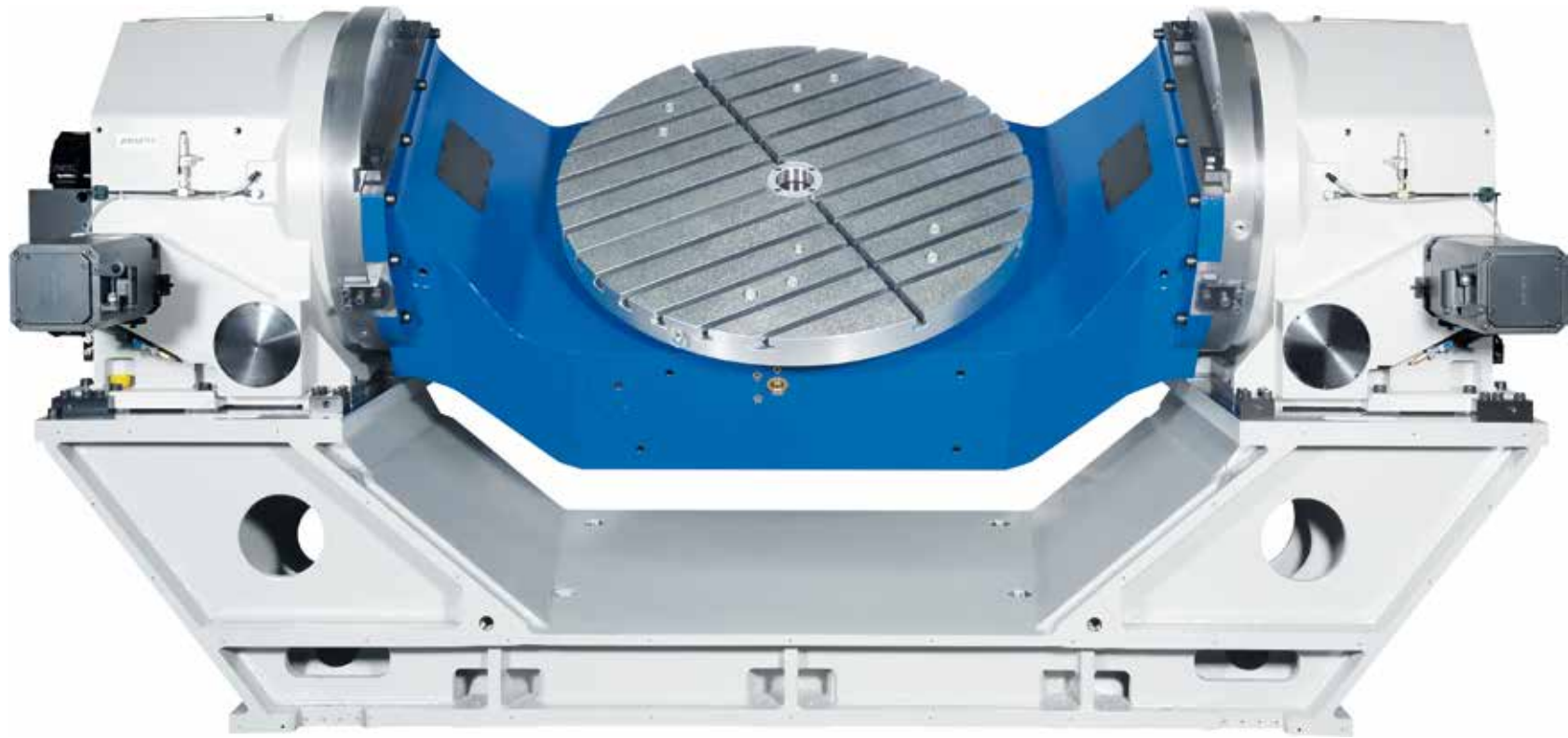

ZAS 1000 C

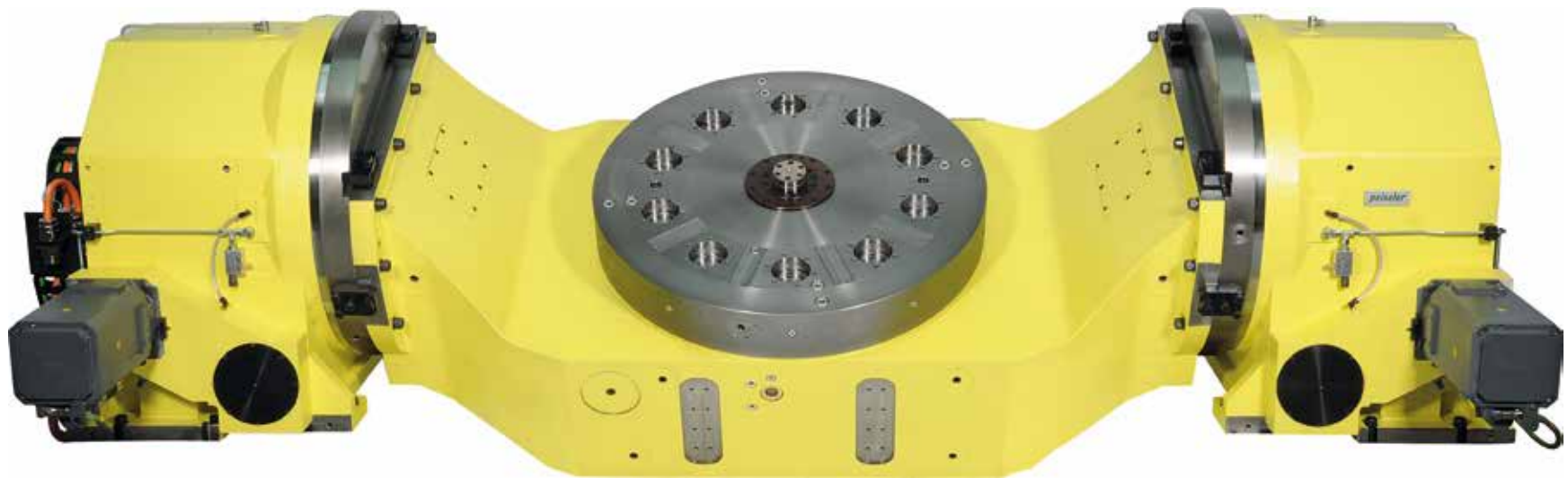



ZASD 100



ZASD 125



ZASD 125 B



ZASD 160



ZASD 160 B



ZASD 160 V



ZASD 160 C





ZASD 200

ZASD 200 G



ZASD 200 2



ZASD 200 2 B



ZASD 280



ZASD 280 B

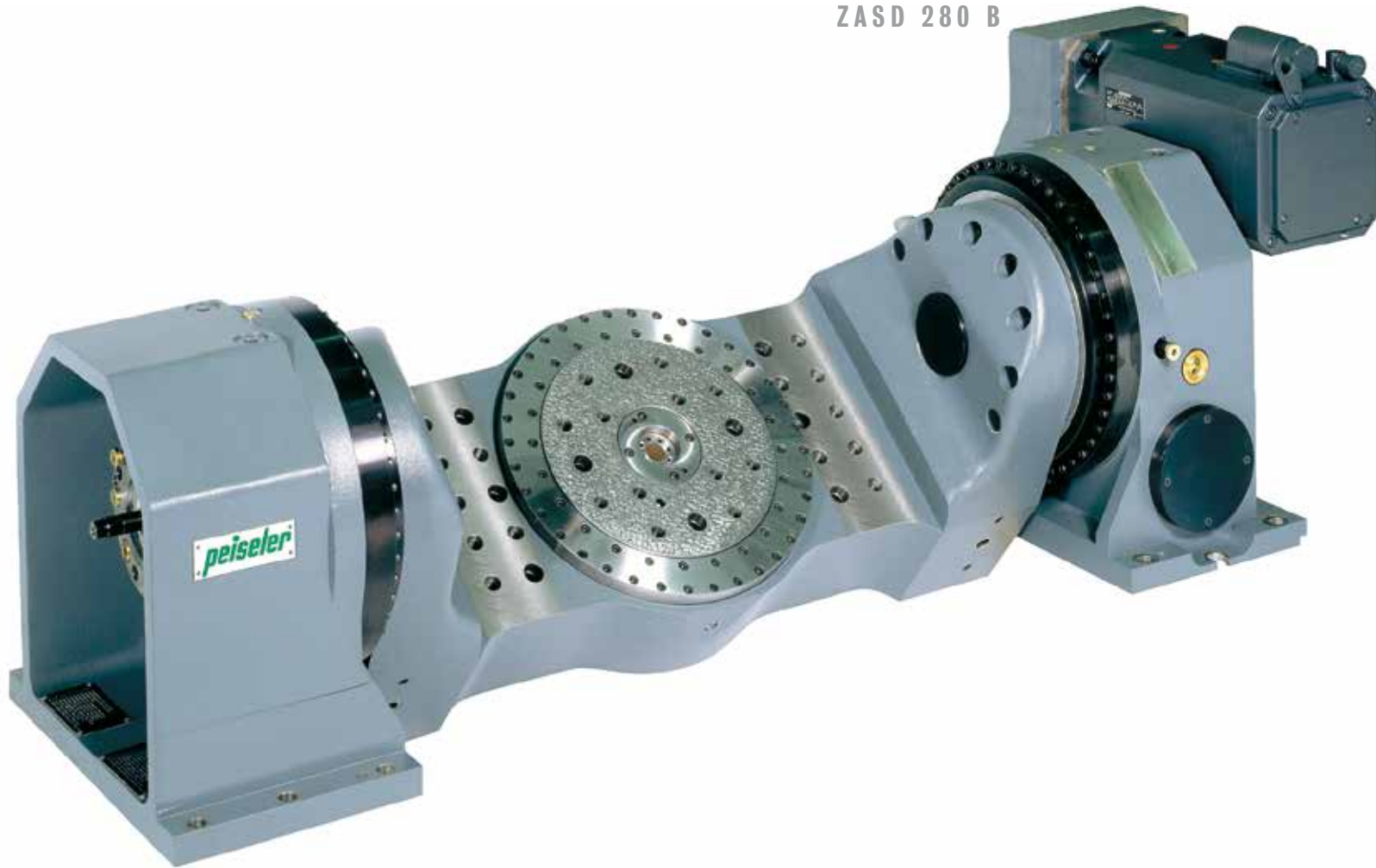

ZASD 280 C



ZASD 280 2

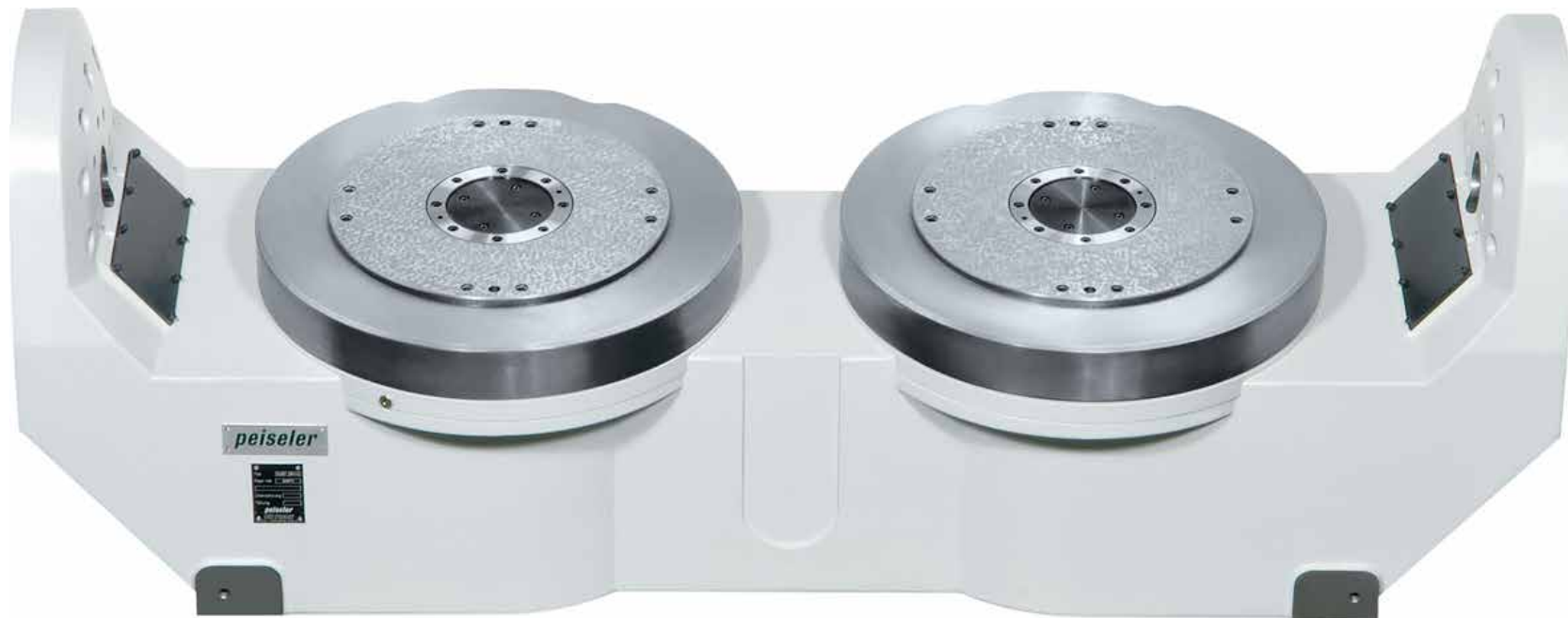

ZASD 320





ZASD 320 C



ZASD 320 D



ZASD 400



ZASD 400 B



ZASD 400 C

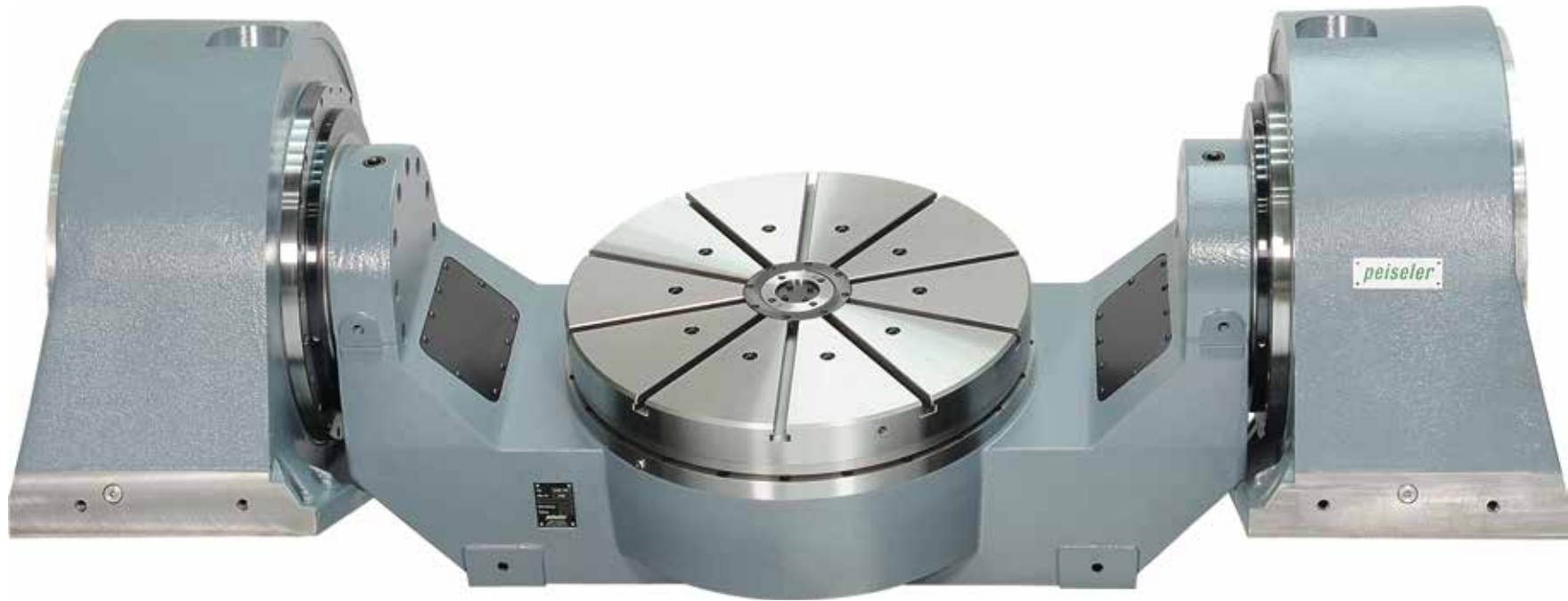

ZASD 400 D

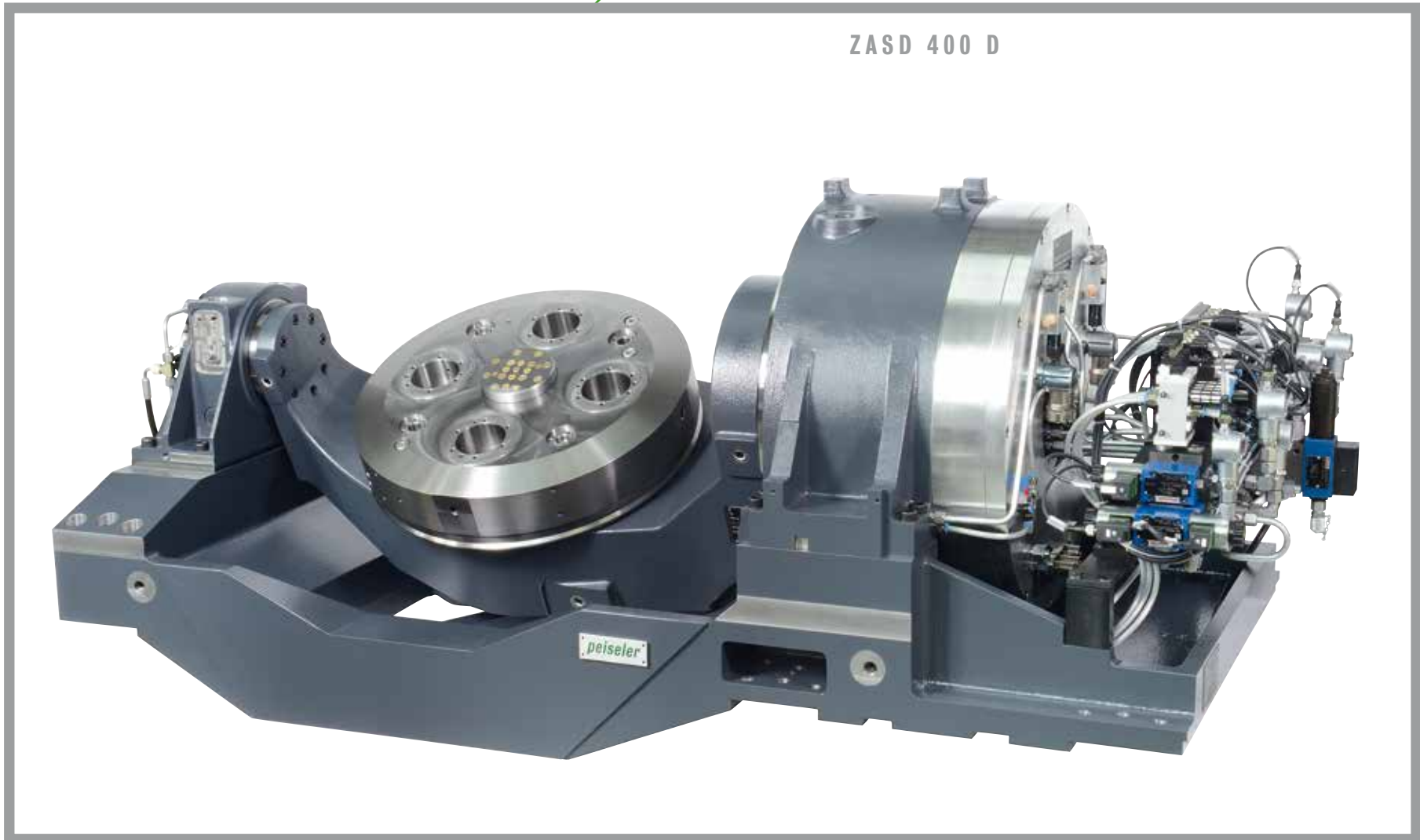

ZASR 630



ZASR 1000

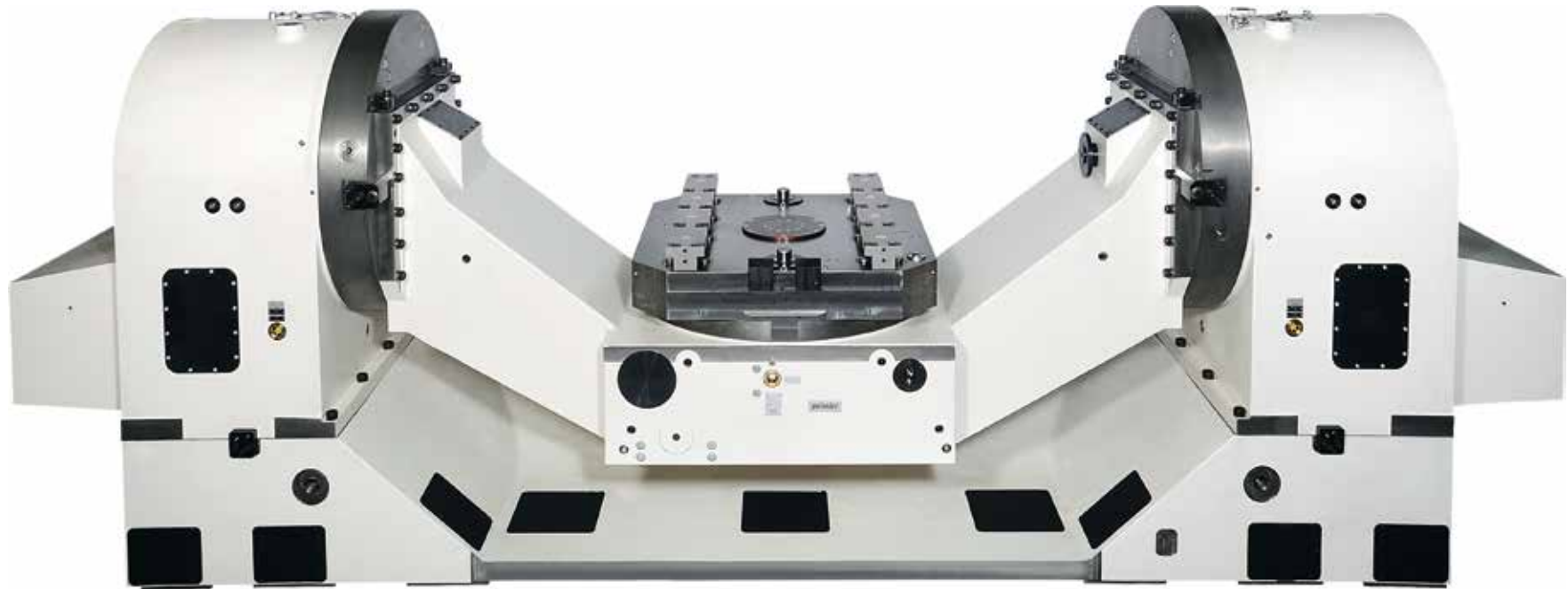

ZATC 125

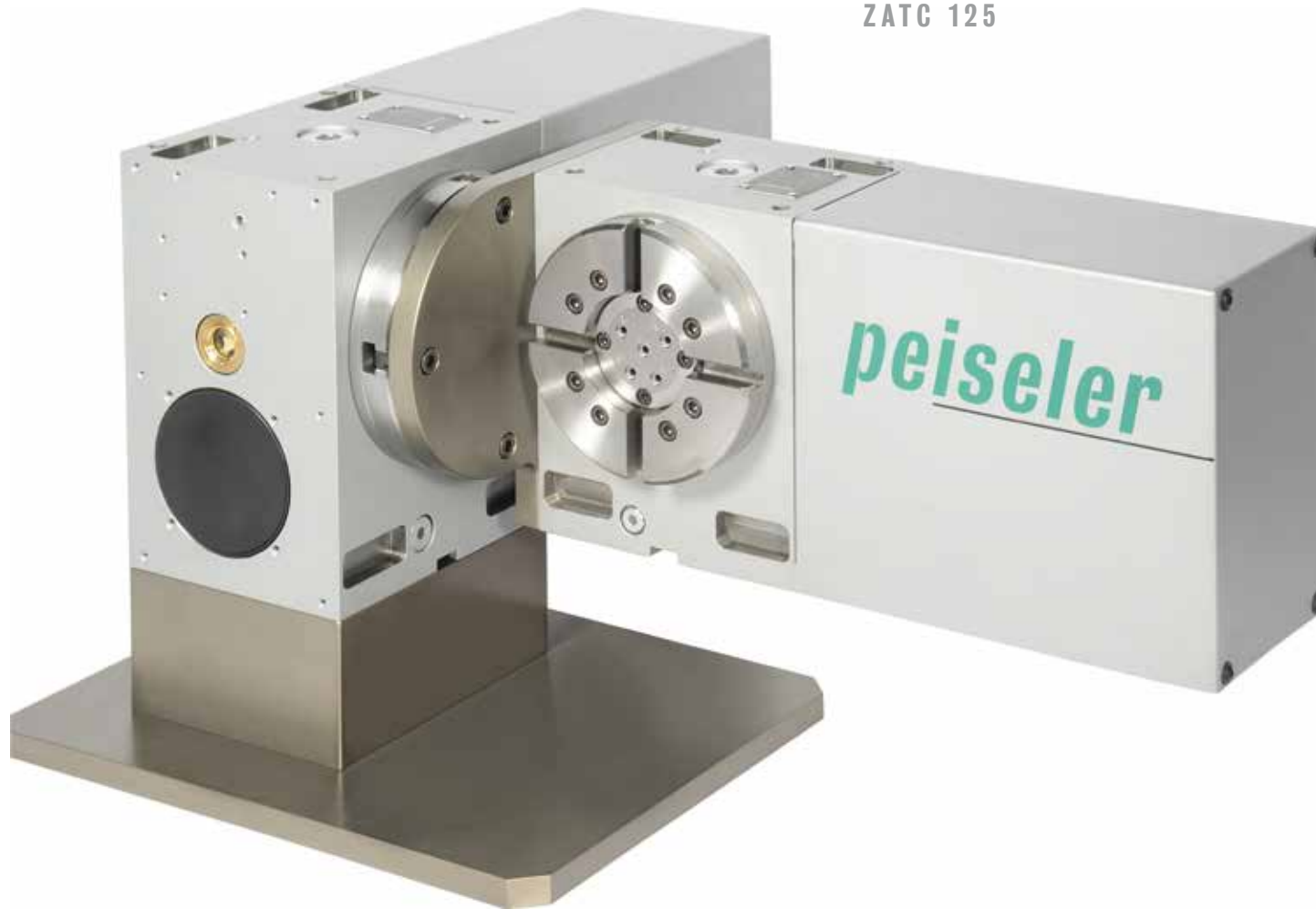

ZATC 160



ZATC 250



ZATC 300



ZATC 300 B



ZXD 160

